

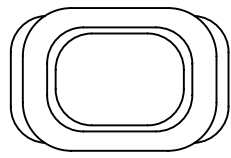

1	2	3	4
RevNo	Revision note	Date	Signature
			Checked

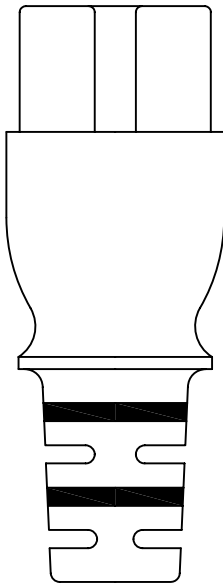
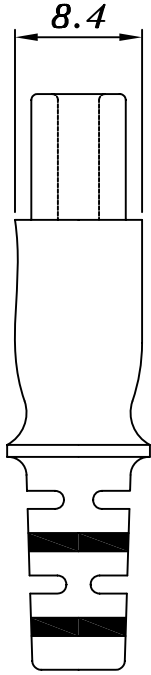
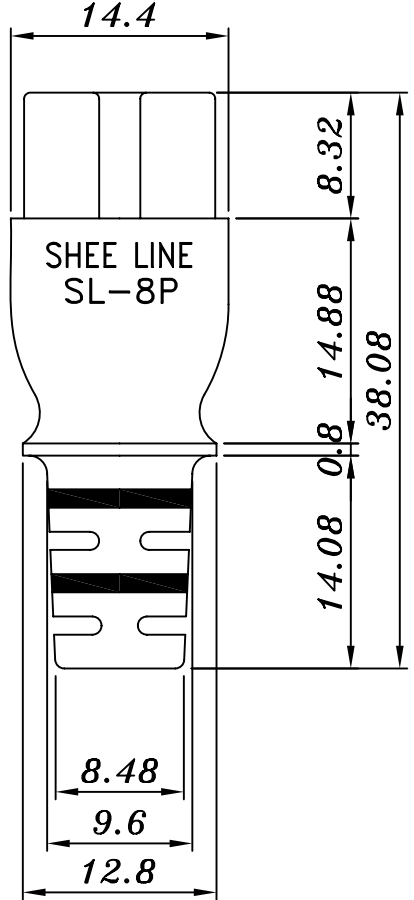
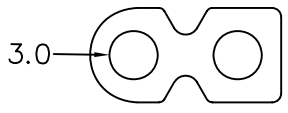
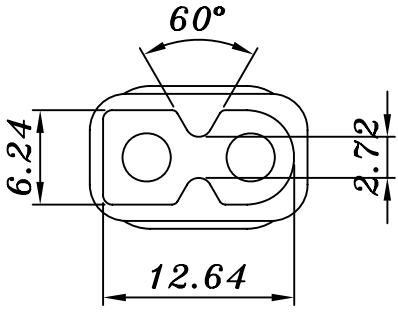

Specification Use Only	Tolerance	Approved:	 升林有限公司	
	> 0 ±0.3	Checked:		
	> 1 ±0.5	Drawing By: Tina Wang		Description:
	> 10 ±0.1	Date:		Material:
	> 20 ±0.2	Rev.1	Unit: mm	
	Angle: ±1		Drawing NO: SL-8P	